



TOYOTA

HILUX
REVO

**POWER
REVEALED**

Contact Information

Indus Motor Company Limited
Plot No. N.W.Z./1/P-1, Port Qasim Authority,
Karachi, Pakistan.
Phone: +92-21-34721100
UAN: +92-21-111-86-96-82 (+92-21-111-TOYOTA)

Customer Assistance Centre

Toll Free: 0800-11123
Phone: +92-21-34721100
Email: customer.relations@toyota-indus.com

FOR MORE INFORMATION
SMS "REVO" TO



TOYOTA



HILUX
REVO

**POWER
REVEALED**



TOYOTA

A LEGACY OF

POWER

The Toyota Hilux REVO has been a leader in the Pakistani automobile market as the dominant 4-wheeler on the road. Synonymous with power and reliability, it is revered due to its utility, ranging from a spacious and luxurious high-capacity family vehicle, to a robust and reliable off roader, making the Hilux REVO nothing short of an engineering marvel. Designed to fulfill any roles it is put in, an eye catching new appearance, more advanced features, and enhanced safety cater to a variety of lifestyles requiring power and durability.

Bound to be a head turner on any road it is a true expression of Power, revealed for every terrain and area of the country.

HILUX
REVO



GEN 08 - 2016



GEN 07 - 2012



GEN 06 - 1997



GEN 05 - 1988



GEN 04 - 1983



GEN 01 - 1968



GEN 02 - 1973



GEN 03 - 1978





HILUX
REVO





TOYOTA

WITNESS THE **POWER**



TRAPEZOIDAL GRILLE

Complementing its off-road persona, the new Hilux REVO is designed to be a more precise and meaner looking machine. Tough and recreational design produces a powerful and exciting pickup.

The front of the REVO has been designed to depict power with a trapezoidal grille with a thick frame, giving it a rugged look with a prominent horizontal axis extending across the headlamps and upper grille.



REAR LED COMBINATION LAMPS



REDESIGNED 18 INCH ALLOY WHEELS



HI GRADE BI-BEAM LED HEAD LAMPS



LED FOG LAMPS

HILUX
REVO





HILUX
REVO





TOYOTA

DRIVEN THE EXPERIENCE OF POWER



REDESIGNED PREMIUM OPTITRON METER

The experience that is the Hilux REVO starts with interior and the cabin. Designed for comfort and maximum accessibility with intelligently designed storage spaces, the interior is an experience of its own.

Considering the need for modern accessibility and information systems during driving, the Combination Meter has been refined to ensure a High-class and Precise feel. With elegant metal tone dials, plated rings and redesigned graphics, one feels the detail that goes into crafting the interior of the new REVO. The MID conveys real time information while driving, like tire turning angles on the display.



4.2 INCH COLOR TFT MID



PREMIUM STEERING SWITCHES





HILUX
REVO



AUTO AIR CONDITIONER



PUSH START AND SMART ENTRY



TYRE TURNING ANGLE IN MID



POWER OUTLETS





TOYOTA

COMFORT AND CONVENIENCE

Sitting inside, the Hilux REVO is a wonder of spatial composition. Designed intuitively, it delivers an experience which is both comfortable and spacious. The seats have been designed to support the driving posture while keeping the experience premium and luxurious with its black leather cabin scheme. The steering wheel features MID, Audio and Call setting switches to keep the driver in control without any distractions. The instrument panel showcases the newly designed tablet style audio head unit with 9-inch display featuring Android OS, 4G connectivity and a Six Speaker surround system. With carefully designed and placed storage spaces and AC vents around the car, it is a vehicle for everyone.



REAR ARMREST



9" TABLET STYLE AUDIO HEADUNIT



DRIVER 8 WAY POWERED SEAT



ILLUMINATED DRIVER CONTROLS



REAR AC VENTS



6 SPEAKERS



METICULOUS NEW BLACK LEATHER FINISH



OVERHEAD CONSOLE AND INTERIOR LAMP



REAR DECK WITH BEDLINER



HILUX
REVO



TOYOTA

HILUX
REVO





TOYOTA

GAUGE THE **POWER**



CRUISE CONTROL

The new Toyota REVO flaunts a powerful Diesel engine from Toyota's internationally acclaimed GD series. Major focus has been put on the Power, Torque and Fuel Economy Enhancement of the New Generation 2.8 Liter 1GD engine. Now enjoy higher power and torque output that ensures powerful acceleration across a wider power band. The REVO's steering system has been enhanced with Variable Flow Control (VFC) power steering, which enhances the steering feel through more realistic feedback relative to the vehicle's speed; and being more fuel efficient than traditional power steering systems.

In addition, by shifting to 4WD Low, the VFC system recalibrates and provides a constant level of assist via steering.



DRIVE MODES



NEW VARIABLE FLOW CONTROL STEERING



**NEW GENERATION 2.8L
1GD-FTV ENGINE**

**MAX OUTPUT 150KW
@ 3000-3400 RPM**

**MAX TORQUE 500NM
@ 1600-2800 RPM**





TOYOTA

4X4 POWER

DRIVE PACK

The Revo has been built from ground up to handle both driving on and off the road - built on body on frame platform with proper 4x4 functionality, the Revo comes loaded with a host of off-road features that augment the driving experience, and provide the driver unprecedented control over all terrains.



LIMITED SLIP DIFFERENTIAL (LSD)

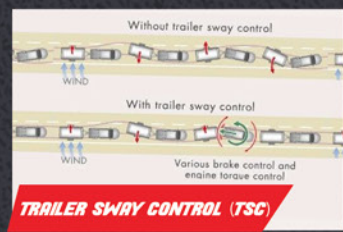

TRAILER SWAY CONTROL (TSC)



HILL-START ASSIST CONTROL (HAC)



ACTIVE TRACTION CONTROL (A-TRC)



DOWNHILL ASSIST CONTROL (DAC)

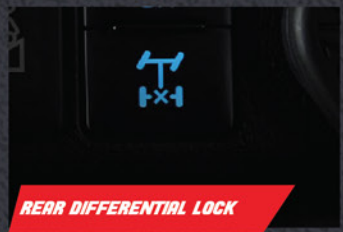

REAR DIFFERENTIAL LOCK



4WD DRIVETRAIN





HILUX
REVO

ADVANCED TRACTION

CONTROL

Toyota's Stepped traction strategy allows the driver to go wherever the journey takes them with confidence. With the addition of Limited Slip Differential, the REVO is now equipped with 5 levels of traction capabilities.

- 1) Traction Control (TRC) is the first step – this helps get you going even in 2WD. TRC will cut engine power and apply selective braking if needed.
- 2) If more capability is needed in 2WD mode, the driver can push the TRC OFF switch to engage AUTO LSD on the rear drive wheels. AUTO LSD does not limit engine output. It enhances start-off performance by applying drive torque to the wheel or wheels that have the best traction.
- 3) If additional traction is required, the driver can engage 4WD HIGH. A-TRC automatically operates from this point if the VSC system judges it necessary. A-TRC monitors the wheel speed sensors and yaw rate and deceleration sensors to identify wheel slip during acceleration, then adjusts the throttle to reduce engine power and increases brake pressure to each individual wheel to slow the wheel and restore traction.
- 4) For even more traction, the driver can engage 4WD LO with A-TRC. In 4WD LO range, priority is given to engine power and rapid braking.
- 5) If the above is not sufficient, the Revo also comes with Rear Differential Lock* that is effective when driving in off-road conditions when one of the rear wheels is not gaining sufficient traction.

*Refer to owners manual for correct operation of Rear Differential Lock





HILUX
REVO





TOYOTA

SAFETY, STABILITY AND SECURITY

The REVO experience is about staying in control at all times, providing peace of mind and prioritising the safety of your loved ones. For the new REVO, the frame/body and suspension have been refined to optimize the damping force of the shock absorbers. Similarly, the No.2 cabin mount is hardened with increased horizontal rigidity for better vibration absorption. This makes it a comfortable and smooth ride even in the most irregular of conditions.



IMPACT ABSORBING STRUCTURES

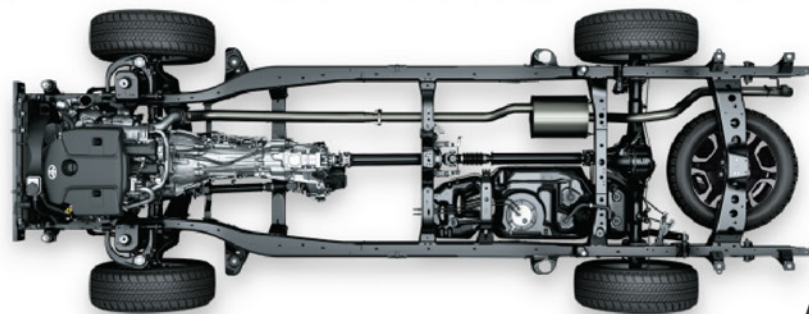

FRONT 3-POINT ELR FRONT SEATBELTS WITH PRETENSIONER AND FORCE LIMITER



REFINED SUSPENSION & CABIN MOUNTS

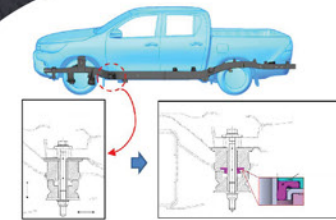

SRS AIRBAGS



FRONT SEATBELTS REMINDER



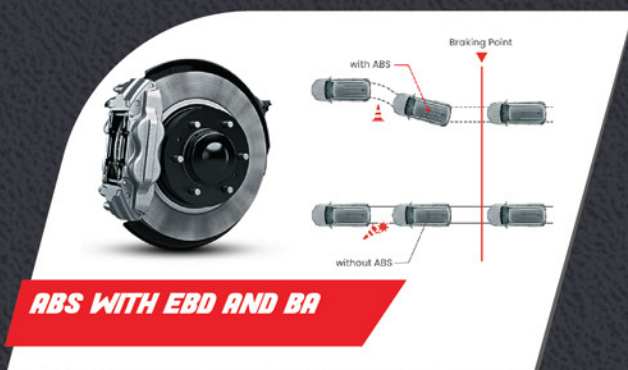

ABS WITH EBD AND BA

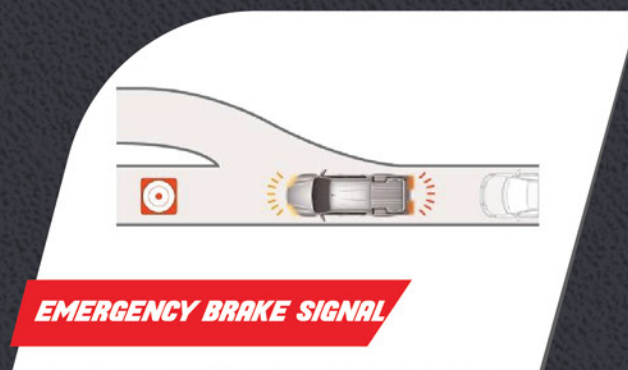

EMERGENCY BRAKE SIGNAL



DRIVE START CONTROL

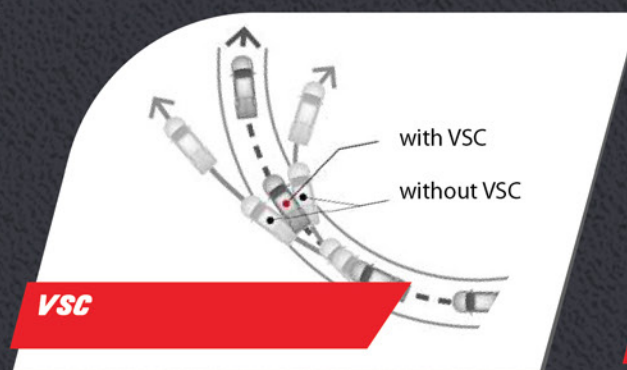

VSC



SPEED SENSING DOOR-LOCKS



IMMOBILIZER SYSTEM WITH ALARM



REAR ISOFIX CHILD SEAT FIXTURE





HILUX
REVO





HILUX
REVO

GRAPHITE

SILVER METALLIC

DARK TEAL MICA

SUPER WHITE

ATTITUDE BLACK



All colours are subject to availability and colours may vary from print



TOYOTA

ACCESSORIES



FOG LAMP GARNISH - CHROME



FRONT GRILLE GARNISH



HOOD LIFT ASSIST



FRONT UNDER RUN



BLIND SPOT MIRROR



EXHRUST TIP





TOYOTA



SCUFF PLATE



REAR LAMP GARNISH -
GLOSS DARK GREY



SIDE MOULDING



WIRELESS CHARGER



SIDE VISOR

HILUX
REVO





HILUX
REVO





TOYOTA

FULL SPECIFICATIONS

DIMENSIONS

Table with 5 columns: Body Type, Exterior, Wheelbase, Tread, Overhang, Min. Running Ground Clearance*, Min. Turning Radius, Interior, Seating Capacity (persons), Gross Vehicle Weight, Curb Weight, Fuel Tank Capacity. Rows include Hilux E, Revo G M/T, Revo G A/T, and Revo V A/T.

* (W/O axle, 1 passenger)

ENGINE SPECIFICATIONS

Table with 5 columns: Engine Code, Variable Nozzle Turbocharger, Intercooler, Displacement (cm3), No. of Cyls. & Arrangement, Fuel System, Max. Output (kW @ rpm), Max. Torque (Nm @ rpm). Rows include Hilux E, Revo G M/T, Revo G A/T, and Revo V A/T.

PERFORMANCE

Table with 5 columns: Exhaust Emission Standard, Transmission, Transfer, Differential Lock, Drive Modes (Eco / Pwr s/w), Brake Type, Brake Control Valve, Tyre & Wheel, Suspension Type, Stabilizer Bar, Cruise Control, Steering Type. Rows include Hilux E, Revo G M/T, Revo G A/T, and Revo V A/T.

SAFETY

Table with 5 columns: Vehicle Stability Control, Emergency Brake Signal, Drive Start Control, Tire-Turning Angle (Shown in MID), Engine Oil Leveling Warning, Light Reminder, Key Reminder, Shift-Lock System, Clutch-Start Safety, Anti-Theft System, Anti-Lock Braking System, Seatbelt, Child-Restraint System, SRS Airbag, Knee Airbag, On/Off Switch, Airbag Indicator. Rows include Hilux E, Revo G M/T, Revo G A/T, and Revo V A/T.



FULL SPECIFICATIONS

EXTERIOR

Table with 5 columns: Headlamp, Daytime Running Lamps, Front Grille, Front Foglamp, Side-Turn Signal, Outer Rear View Mirror, Door Handle, Doorbolt Moulding, Side Visors, Side-Step, Dock Guard Frame, Rear Glass, Tailamps, High Mount Stop Lamp, Tailgate Handle, Bumper, Mud Guard, Air Spats. Rows include Hilux E, Revo G M/T, Revo G A/T, and Revo V A/T.

INTERIOR

Table with 5 columns: Cabin Scheme, Seat Material, Door Trim, Instrument Panel, Console Box with air register (air vent), Power Door Lock, Push Start, Wireless Key, Door Handle, Power Windows, Window Wiper, Illuminated Entry System, Coat Hook, Shopping Hook, Sun Visor, Heater, Air Conditioner, Side Defroster, Cool & Hot Box, Head Rest, Rear Armrest, Front Seat, Rear Seat, Accessory Connector, Steering, Speedometer, Multi Info Display, Economy Meter, Infotainment System. Rows include Hilux E, Revo G M/T, Revo G A/T, and Revo V A/T.



HILUX
REVO



AUTO AIR CONDITIONER



PUSH START AND SMART ENTRY



4X4 DRIVETRAIN

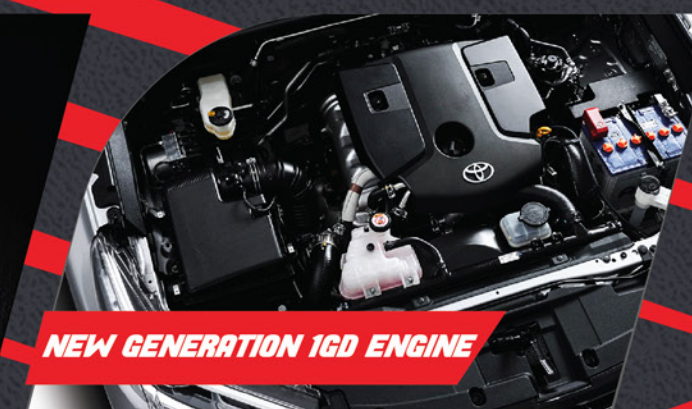

NEW GENERATION 1GD ENGINE



TYRE TURNING ANGLE IN MID



POWER OUTLETS



DRIVE MODES



REAR LED COMBINATION LAMPS



REDESIGNED 18 INCH ALLOY WHEELS



4.2 INCH COLOR TFT MID



SIDE VISOR



PREMIUM STEERING SWITCHES



HILUX
REVO



HI GRADE BI-BEAM LED HEAD LAMPS



VARIABLE FLOW CONTROL POWER STEERING



SRS AIRBAGS

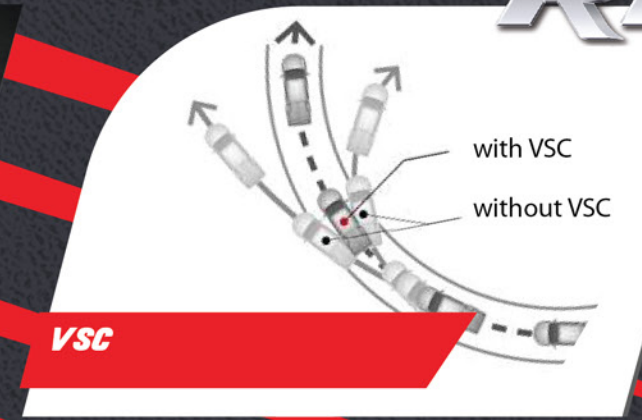

VSC



DOWNHILL ASSIST CONTROL



HILL START ASSIST CONTROL



REAR DIFFERENTIAL LOCK SYSTEM



DRIVE START CONTROL



LIMITED SLIP DIFFERENTIAL

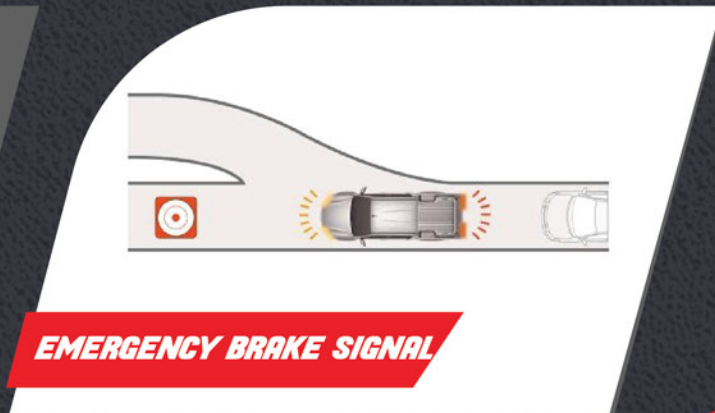

EMERGENCY BRAKE SIGNAL



ADVANCED TRACTION CONTROL

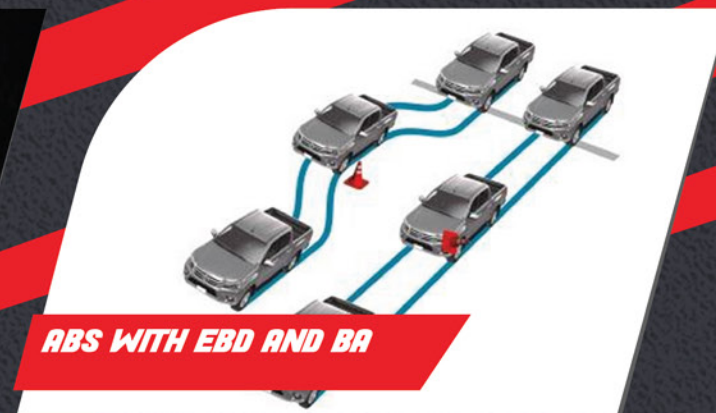

ABS WITH EBD AND BA



HILUX
REVO

EXCHANGE WITH EASE.

**TOYOTA SURE
YOUR ONE WINDOW SOLUTION**

- **GET FREE EVALUATION OF YOUR CURRENT VEHICLE**
- **FINALISE THE DEAL**
- **GO WITH YOUR BRAND NEW TOYOTA FORTUNER**



INDUS MOTOR COMPANY LIMITED

It's a Promise



www.toyotasure.com.pk | [@ToyotaSurePk](https://www.facebook.com/ToyotaSurePk) | [@toyotasurepk](https://www.instagram.com/toyotasurepk)



EVERY TOYOTA IS A SYMBOL OF OUR PROMISE FOR QUALITY

At Toyota, for us our customers always come first and their safety is our top priority, which is why when our loyal customers choose to own a Toyota, we make sure that they find trust and peace of mind that they deserve. From 3 years or 100,000 km Mileage Warranty to Unparalleled Quality, from Durability and Reliability (Q.D.R.) to maintenance and grooming, Toyota ensures an unmatched level of safety with Body Reinforcements. We provide ISOFIX Child Seat Anchors and Immobilizer to ensure that every journey with Toyota is secure and satisfying. It is this level of dedication and attention to detail that has made us Pakistan's most loved, reliable and trusted vehicle.

VALUE ADDED SERVICES



Extend your warranty to up to 5 years



Lock in your maintenance contract and stay worry-free



Avail comprehensive insurance plan for a greater peace of mind



SALES



SERVICE



SPARE PARTS



T-SURE

CERTIFIED BY TOYOTA EXPERTS

TOYOTA SURE
Certified Used Vehicles



TOYOTA



Toll Free: 0800 11123



SMS "FORTUNER" FOR MORE INFORMATION

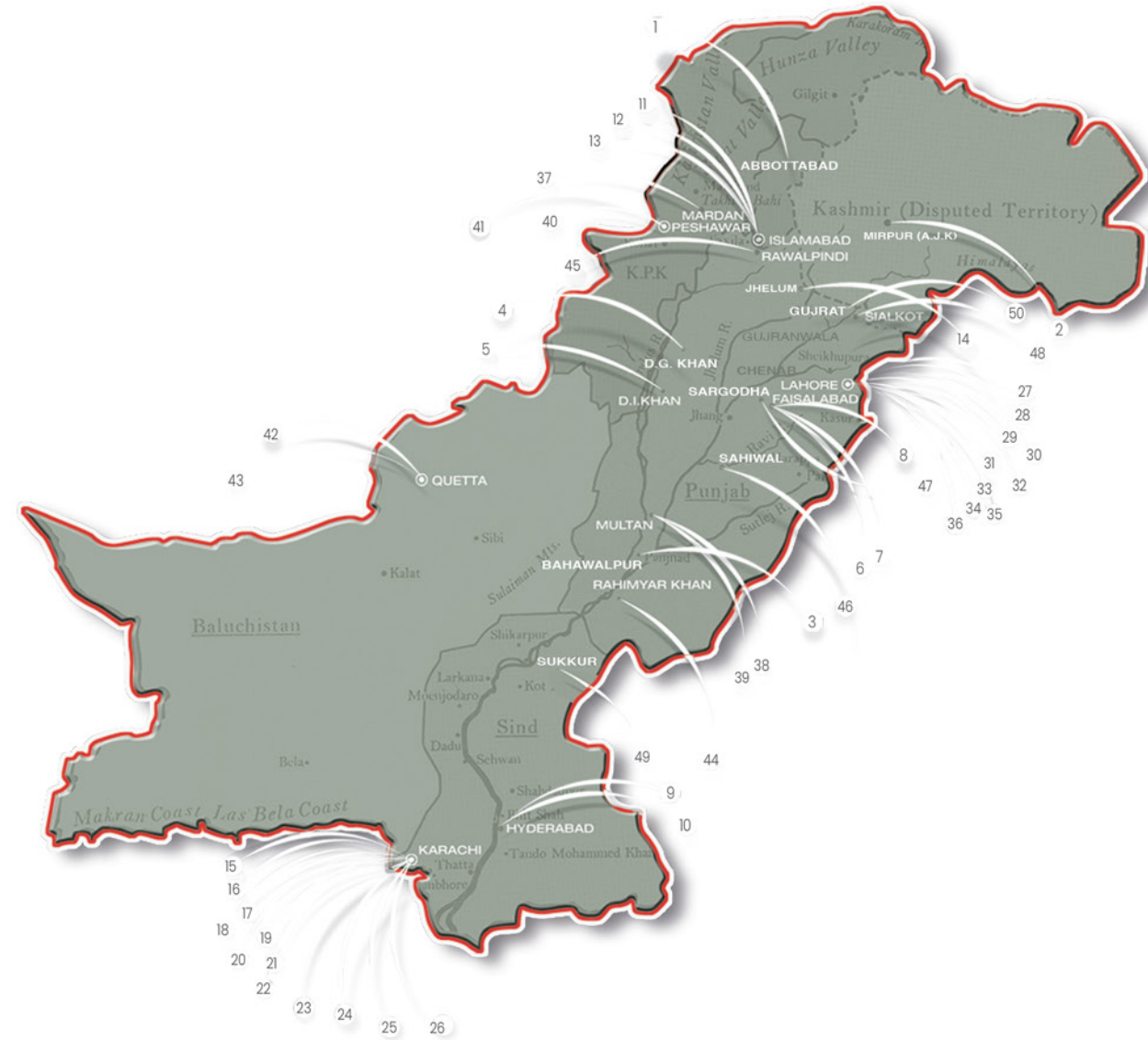

WE ARE PRESENT THROUGHOUT THE NATION

- ABBOTTABAD**
- 1. TOYOTA ABBOTT MOTOR - PHONE: (0992) 380882
- AZAD KASHMIR**
- 2. TOYOTA AZAD MOTORS - PHONE: (05827) 432803-5 / 434297-99
- BAHAWALPUR**
- 3. TOYOTA BAHAWALPUR MOTORS - PHONE: (062) 2889941-42, 111-111-167
- D.G. KHAN**
- 4. TOYOTA D.G. KHAN MOTORS - PHONE: (064) 2845626
- D.I. KHAN**
- 5. TOYOTA D.I. KHAN MOTORS - PHONE: (0966) 716891 (0966) 716792-3
- FAISALABAD**
- 6. TOYOTA FAISALABAD MOTORS - PHONE: (041) 8719902, 8712002, 8712004 (041) 8722002-7 / 111-000-052
- 7. TOYOTA LYALLPUR MOTORS - PHONE: (041) 8811021-24
- 8. TOYOTA CHENAB MOTORS - PHONE: (041) 2423790, 2423793
- HYDERABAD**
- 9. TOYOTA HYDERABAD MOTORS - PHONE: (022) 3885121-5
- 10. TOYOTA POINT MOTORS - PHONE: (022) 2661770-3
- ISLAMABAD**
- 11. TOYOTA CAPITAL MOTORS - PHONE: (051) 4432027 (051) 4431711 / 111-142-142
- 12. TOYOTA ISLAMABAD MOTORS - PHONE: (051) 2820533 (051) 2270461-6 / 111-000-037
- 13. TOYOTA GT MOTORS - PHONE: (051) 2227607, 2227860-4
- JHELUM**
- 14. TOYOTA JHELUM MOTORS - PHONE: (0544) 275467-68
- KARACHI**
- 15. TOYOTA CENTRAL MOTORS - PHONE: (021) 34311155 (021) 111-786-122 / 34532246-50 / 34536246-49
- 16. TOYOTA SOCIETY MOTORS - PHONE: (021) 34381027 / 34383213-4 / 111-786-113
- 17. TOYOTA EASTERN MOTORS - PHONE: (021) 34614077 / 34614177
- 18. TOYOTA UNIVERSITY MOTORS - PHONE: (021) 34940417 / 34941747
- 19. TOYOTA SOUTHERN MOTORS - PHONE: (021) 111-876-111 / 35062478 / 35053181-6
- 20. TOYOTA DEFENCE MOTORS - PHONE: (021) 111-836-836 / 35888314 / 35386022-7 (021) 32020583
- 21. TOYOTA WESTERN MOTORS - PHONE: (021) 32572420 (021) 32564531-5 / 111-800-786
- 22. TOYOTA SHAHRAH-E-FAISAL MOTORS - PHONE: (021) 34600518-20
- 23. TOYOTA HIGHWAY MOTORS - PHONE: (021) 36880702-04 / 111-009-000
- 24. TOYOTA CREEK MOTORS - PHONE: (021) 35092211-3
- 25. TOYOTA CLIFTON MOTORS - PHONE: (021) 35302523
- 26. TOYOTA PORT QASIM MOTORS - PHONE: (021) 38910507-9
- LAHORE**
- 27. TOYOTA RAVI MOTORS - PHONE: (042) 35426961-64, 37580705, 111-700-900
- 28. TOYOTA SHAHEEN MOTORS - PHONE: (042) 37566296-98 / 111-300-700
- 29. TOYOTA TOWNSHIP MOTORS - PHONE: (042) 35885014 / 111-393-939
- 30. TOYOTA SAHARA MOTORS - PHONE: (042) 37576218 / 37581253 (042) 111-383-838 / 37597670 (D)
- 31. TOYOTA GARDEN MOTORS - PHONE: (042) 111-595-959 / 35868256
- 32. TOYOTA WALTON MOTORS - PHONE: (042) 111-008-009 / 36662981-82
- 33. TOYOTA CANTT MOTORS - PHONE: (042) 36613401-10
- 34. TOYOTA AIRPORT MOTORS - PHONE: (042) 111-880-990
- 35. TOYOTA JINNAH MOTORS - PHONE: (042) 111-119-696
- 36. TOYOTA HN MOTORS - PHONE: (042) 111-000-095
- MARDAN**
- 37. TOYOTA MARDAN MOTORS - PHONE: (0937) 873005 (0937) 873001-4
- MULTAN**
- 38. TOYOTA MULTAN MOTORS - PHONE: (061) 6522481 (061) 6522482-83 / 111-111-343
- 39. TOYOTA CITY MOTORS - PHONE: (061) 4580792 (061) 111-111-342 / 4541925 / 4580793 / 4542488
- PESHAWAR**
- 40. TOYOTA FRONTIER MOTORS - PHONE: (091) 5701002-5 / 5841626 / 111-235-236
- 41. TOYOTA KHYBER MOTORS - PHONE: (091) 2586931-4
- QUETTA**
- 42. TOYOTA ZARGHOON MOTORS - PHONE: (081) 2450444
- 43. TOYOTA QUETTA MOTORS - PHONE: (081) 111-876-876
- RAHIMYAR KHAN**
- 44. TOYOTA ROYAL MOTORS - PHONE: (068) 5885090-92
- RAWALPINDI**
- 45. TOYOTA RAWAL MOTORS - PHONE: (051) 4917214 (051) 4917200-4
- SAHIWAL**
- 46. TOYOTA SAHIWAL MOTORS - PHONE: (040) 4502345-6 (042) 111-700-900
- SARGODHA**
- 47. TOYOTA SARGODHA MOTORS - PHONE: (048) 3221801-02 / 111-222-456
- SIALKOT**
- 48. TOYOTA SIALKOT CITY MOTORS - PHONE: (052) 3308131-33 & 37
- SUKKUR**
- 49. TOYOTA SUKKUR MOTORS - PHONE: (024) 3558141-43 / (071) 111-785-587
- GUJRAT**
- 50. TOYOTA GUJRAT MOTORS - PHONE: (053) 111-111-153

Dealerships marked with T-Sure service available.

